

Luxury-I

Electronic lock



Digital Locker Lock – Premium

- For office, school, gym and various lockers
- Combined LOCK and LUXURY
- Passcode or RFID Mifare
- 1 time or permanent user mode
- 3 levels key and passcode system
- Burglar Alarming Function
- 3 AA Alkaline Battery stands for more than 1 year (10 times per day)
- Battery warning alarms and LED lights.
- Good design awarded
- ROHS compliant eco friendly design

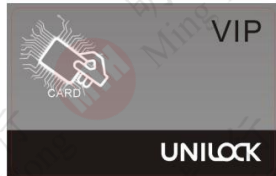
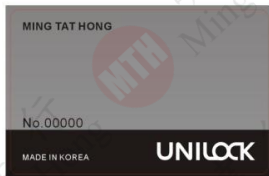

AU5001
AU5002



Silver
AU 2001A
LL 83AR-S



Black
AU 2001B
LL 83AR-B



Gold
AU 2001C
LL 83AR-G

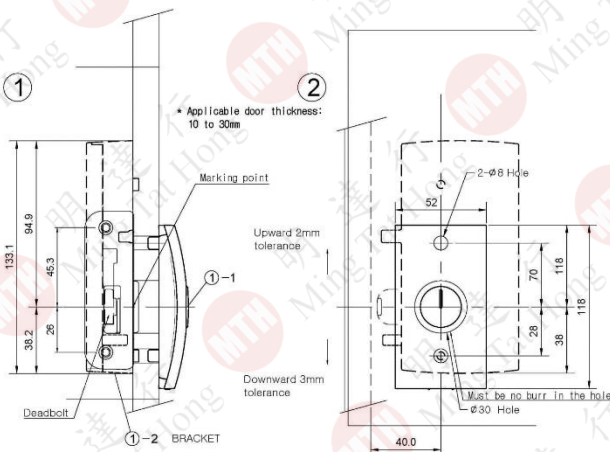

③ Ex) covered length 13mm + 40mm = 53mm

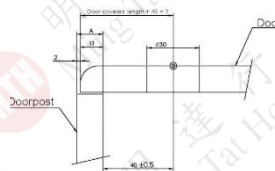

Note : Most lockers has different covered dimension

④ Leftward 2.0mm tolerance

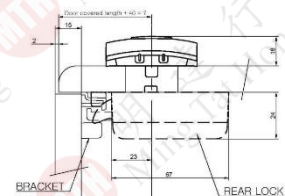

*** 40mm From Doorpost

Maeari

Electronic lock



AU1001 ML32HPV
 AU1002 ML32HPH
 AU1011 ML22HPV
 AU1012 ML22HPH

Electronic lock



AU1021 ML81APV

Digital Furniture Lock

- For cabinet, drawer and various office furniture.
- Electro-mechanical Cam Lock or Multi-Drawer Lock (ML3 and ML2)
- Maximized strength and ease of installation as mechanical lock.
- Minimized European style design
- Selectable modular design
- 2 levels passcode or RFID Mifare
- Low power consumption
- Auto locking type – ML81
- Good design awarded
- Wide marketability for both of before and after market



AU1001 U-Maeari ML32HPV 電子鎖
AU1002 U-Maeari ML32HPH 電子鎖
AU1011 U-Maeari ML22HPV 電子鎖
AU1012 U-Maeari ML22HPH 電子鎖



AU1021 U-Maeari ML81APV 電子鎖



AU2001A U-Loxury I LL83AR-S 電子鎖(銀)



AU2001B U-Loxury I LL83AR-B 電子鎖(黑)



AU2001C U-Loxury I LL83AR-G 電子鎖(金)

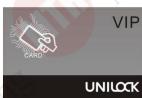

AU5001 感應卡-主(1套3張)
AU5002 感應卡-單配

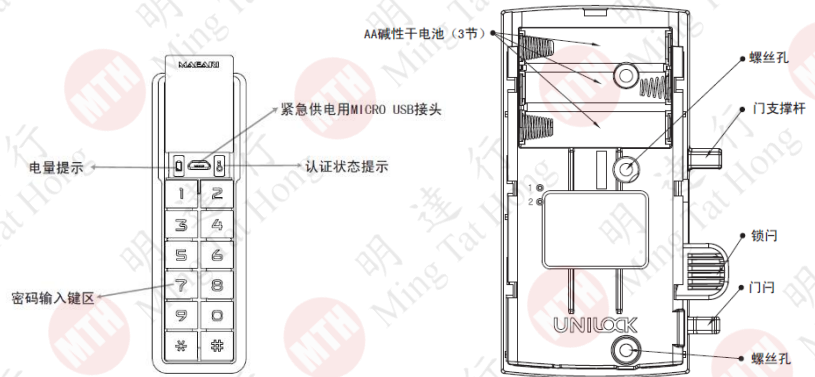

密碼的使用與變更

密碼使用與變更前需注意事項

- 出廠密碼設定為“1111”
- 密碼(4-12) 使用或變更
- 輸入密碼過程中想退出時按“*”鍵後可以重新輸入
- 密碼輸入有誤時, 會有兩聲“啾~”的提示音

密碼使用方法:

开门时



- 按“#”+“密码”+“#”键后
- 发生提示音“3回”后
- “绿色图标”会闪 3回 之后解除锁定。

电量不足时



- 电量用尽时会发生5次提示音的同时“红色图标”会闪
- 这时需要更换新电池

使用中的密碼變更新密碼的方法:

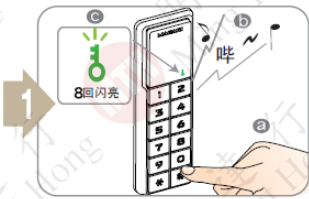

- 按4秒“#”键
- 稍长的提示音“啾~”响1回
- “绿色图标”闪8秒



- 输入密码后按“*”键
- “2回”声响发生后
- “绿色图标”闪8秒时
- 新的密码输入后按“#”



- 发生2回声音
- “绿色图标”闪8秒时
- 把新密码再输入后按“#”



- 发生3回响声后
- “红色图标”闪5回时才会完成密码更改

功能設定

1) 提示音開或/關的設定:

开提示音设定



先按住数字“1”的状态下按“#”过2秒之后会听到2回声响的同时绿色图标会闪2回完成开提示音设定

关提示音设定



先按住数字“0”的状态下按“#”过2秒之后会听到2回声响的同时绿色图标会闪2回完成关提示音设定

※ 在静音状态下, 因为没有声音, 每回按键时会看到绿色图标会闪 (间隔很短)

2) RESET 功能:

RESET 功能



“#”与“*”同时按时会听到5回声响, 这与关闭电源有相同的RESET效果

※ RESET功能是用来产品的初使化, 当产品没有任何反应时或者产品有异常时通过此功能将产品复恢复到出厂状态